

simple circuit

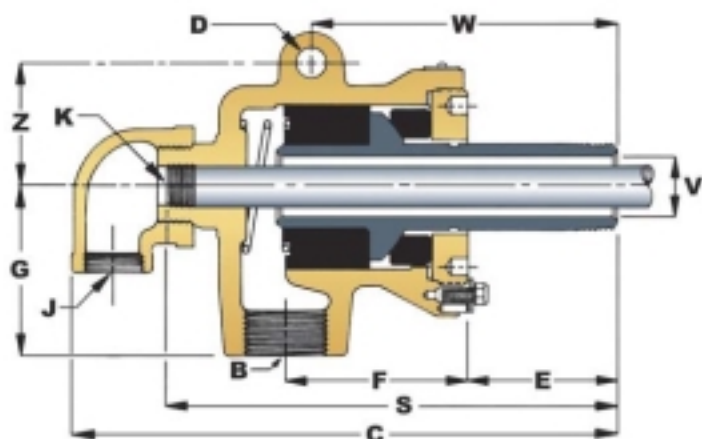

double circulation

Série 8000

Le raccord rotatif **série 8000** est un modèle parfaitement adapté pour les applications vapeur.

- Une patte de fixation empêche la rotation du boîtier pendant le fonctionnement.
- Le palier spécial graphite-carbone ne nécessite aucune lubrification.
- Cette série existe en version à bride à fixation rapide et axe fileté.

La série **8000T** est conçue spécialement pour utilisation dans l'industrie textile.

- L'arbre et le boîtier sont prévus pour assurer une grande résistance à la corrosion, un ressort puissant permet l'utilisation en basse pression ou sous vide faible.

La série **8000HO**, de même conception que le 8000 standard, permet de véhiculer des fluides caloporteurs.

- De qualité spéciale, il permet des applications à très hautes températures.

Caractéristiques d'utilisation	8000
Eau : pression maxi	17 bar
Eau : température maxi	190°C
Vapeur : pression maxi	10,2 bar
Vapeur : température maxi	190°C
Fluide thermique : pression maxi	6,8 bar
Fluide thermique : température maxi	190°C
Rotation maxi NPT	700 tr/min
Rotation maxi métrique	1500 tr/min
Rotation maxi pour de l'air	320 tr/min

Caractéristiques d'utilisation	8000-HO
Eau : pression maxi	17 bar
Eau : température maxi	190°C
Vapeur : pression maxi	10,2 bar
Vapeur : température maxi	190°C
Fluide thermique : pression maxi	6,8 bar
Fluide thermique : température maxi	315°C
Rotation maxi NPT	700 tr/min
Rotation maxi métrique	1500 tr/min
Rotation maxi pour de l'air	320 tr/min

8000 simple circuit 1/4" à 4"

A (BSP)	Référence	B (BSP)	F	E	G	C	W	Z	O
1/2"	8821-GD	1/2"	2 1/2" (64)	2 1/8" (54)	2" (51)	6 1/4" (159)	4 7/16" (112)	1 5/8" (42)	15/32" (12)
	8821-GD-HD								
	8821-GG-FGD								
	8821-Q-FGD								
	8821-Q-FGD-HD								
3/4"	8827-GD	3/4"	2 1/2" (64)	2 3/16" (55.5)	2 3/8" (60)	6 3/8" (162)	4 11/16" (119)	1 13/16" (46)	15/32" (12)
	8827-GD-HD								
	8827-GG-FGD								
	8827-Q-FGD								
	8827-Q-FGD-HD								
1"	8834-Q-FGD 8834-Q-FGD-HD	1"	2 3/4" (70)	2 5/16" (59)	2 5/8" (67)	7 1/8" (181)	4 7/8" (123)	1 7/8" (48)	15/32" (12)
1 1/4"	8842-GD	1 1/4"	3 3/16" (81)	2 1/2" (64)	3 (76)	8 1/8" (206)	5 5/8" (142)	2 1/8" (53)	5/8" (15)
	8842-GD-HD								
	8842-GG-FGD								
	8842-Q-FGD								
	8842-Q-FGD-HD								
1 1/2"	8849-GD	1 1/2"	3 3/4" (95)	2 1/2" (64)	3 1/2" (89)	8 13/16" (224)	6" (152)	2 7/8" (73)	5/8" (15)
	8849-GD-HD								
	8849-GG-FGD								
	8849-Q-FGD								
	8849-Q-FGD-HD								
2"	8860-GD	2"	4" (102)	2 9/16" (65)	4" (102)	9 1/2" (241)	6 9/16" (167)	3 1/8" (79)	5/8" (15)
	8860-GD-HD								
	8860-GG-FGD								
	8860-Q-FGD								
	8860-Q-FGD-HD								
2 1/2"	8876-GD	2"	5 3/16" (132)	3 3/16" (81)	4 7/16" (113)	10 7/8" (276)	8" (203)	3 9/16" (90)	11/18" (17)
	8876-GD-HD								
	8876-GG-FGD								
	8876-Q-FGD								
	8876-Q-FGD-HD								
3"	8890-GD	2 1/2"	5 3/4" (146)	3 5/8" (92)	4 9/16" (116)	12 3/16" (309.5)	8 1/2" (216)	3 31/32" (101)	7/8" (22)
	8890-GD-HD								
	8890-GG-FGD								
	8890-Q-FGD								
	8890-Q-FGD-HD								
4"	88114-GD	4"	8 1/8" (206)	5 7/16" (138)	6 5/16" (160)	16 7/8" (429)	13 1/2" (343)	5 1/8" (130)	1 3/32" (28)
	88114-GD-HD								
	88114-GG-FGD								
	88114-Q-FGD								
	88114-Q-FGD-HD								

8000T

	Arbre BSP	Référence	B (BSP)	V	E	F	S	W	G	O			
Simple circulation	1"	8834-GD-T	1"	1"	2 5/16" (59)	2 3/4" (70)	6 3/16" (157)	4 7/8" (123)	2 5/8" (67)	15/32" (12)			
	1"	8834-GG-FGD-T		(25)									
Double circulation	Arbre BSP	Référence	B (BSP)	J	K (NPSM)	C	D	E	F	S	W	Z	H
	1"	8934-GD-T	1"	1/2"	3/8"	8 3/4"	2 3/4"	2 5/16"	2 3/4"	6 15/16"	4 7/8"	1 7/8"	25/8"
	1"	8934-GG-FGD-T											

sur demande : Filetage A : NPT - BSPP / Taraudage B : NPT - BSPP

Raccords rotatifs série 8900

8000 double circulation 1/2" à 4"

A (BSP)	Référence	B (BSP)	J (BSP)	K NPSM	C	F	E	G	S	W	Z	O	H
1/2"	8921-GD	1/2"	1/2"	1/8"	7 1/2" (190.5)	2 1/2" (64)	2 1/8" (54)	2" (51)	6 1/16" (154)	4 7/16" (112)	1 5/8" (42)	15/32" (12)	2 1/4" (57)
	8921-GD-HD												
	8921-GG-FGD												
	8921-GG-FGD-HD												
3/4"	8927-GD	3/4"	1/2"	1/4"	7 11/16" (195)	2 1/2" (64)	2 3/16" (55.5)	2 3/8" (60)	6 1/4" (158.7)	4 11/16" (119)	1 13/16" (46)	15/32" (12)	2 5/16" (59)
	8927-GD-HD												
	8927-GG-FGD												
	8927-GG-FGD-HD												
1"	8934-Q-FGD	1"	1/2"	3/8"	8 3/4"	2 3/4"	2 5/16"	2 5/8"	6 15/16"	4 7/8"	1 7/8"	15/32"	2 5/8"
	8934-Q-FGD-HD												
1 1/4"	8942-GD	1 1/4"	1/2"	1/2"	9 1/4" (235)	3 3/16" (81)	2 1/2" (64)	3" (76)	7 7/8" (200)	5 5/8" (142)	2 1/8" (53)	5/8" (15)	3 1/8" (79)
	8942-GD-HD												
	8942-GG-FGD												
	8942-GG-FGD-HD												
1 1/2"	8949-GD	1 1/2"	3/4"	3/4"	10 3/8" (263.5)	3 3/4" (95)	2 1/2" (69)	3 1/2" (89)	8 5/8" (219)	6" (152)	2 7/8" (73)	5/8" (15)	3 9/16" (90)
	8949-GD-HD												
	8949-GG-FGD												
	8949-GG-FGD-HD												
2"	8960-GD	2"	1"	3/4"	11 11/16" (297)	4" (102)	2 9/16" (65)	4" (102)	9 1/2" (241)	6 9/16" (167)	3 1/8" (79)	5/8" (15)	4" (102)
	8960-GD-HD												
	8960-GG-FGD												
	8960-GG-FGD-HD												
2 1/2"	8976-GD	2"	1 1/4"	3/4"	14 1/8" (358.8)	5 3/16" (132)	3 3/16" (81)	4 7/16" (113)	11 1/4" (286)	8" (203)	3 9/16" (90)	11/16" (17)	5 1/16" (128)
	8976-GD-HD			3/4"									
	8976-GG-FGD			1"									
	8976-GG-FGD-HD			1"									
	8976-GD-J1			1 1/4"									
	8976-GD-J1-HD			1 1/4"									
	8976-GG-FGD-J1			3/4"									
	8976-GG-FGD-J1-HD			1"									
	8976-GD-J11/4			1" 1/4"									
	8976-GD-J11/4-HD												
	8976-GG-FGD-J11/4												
	8976-GG-FGD-J11/4-HD												
3"	8990-GD	2 1/2"	1 1/4"	1"	17" (431.8)	5 3/4" (146)	3 5/8" (92)	4 9/16" (116)	12 1/2" (318)	8 1/2" (216)	3 31/32" (101)	7/8" (12)	5 9/16" (141)
	8990-GD-HD			1 1/4"									
	8990-GG-FGD			1 1/4"									
	8990-GG-FGD-HD			1 1/4"									
	8990-GD-J11/4			1 1/4"									
	8990-GD-J11/4-HD			1 1/4"									
	8990-GG-FGD-J11/4			1 1/4"									
	8990-GG-FGD-J11/4-HD			1 1/4"									
	8990-GD-J11/2			1 1/2"									
	8990-GD-J11/2-HD			1 1/2"									
	8990-GG-FGD-J11/2			1 1/4"									
	8990-GG-FGD-J11/2-HD			1 1/4"									
8990-Q-FGD	1 1/4"												
8990-Q-FGD-HD	1 1/4"												
8990-Q-FGD-J11/4	1 1/4"												
8990-Q-FGD-J11/4-HD	1 1/4"												
8990-Q-FGD-J11/2	1 1/2"												
8990-Q-FGD-J11/2-HD	1 1/2"												
4"	89114-GD	4"	2 1/2"	2"	24 1/4" (616)	8 1/8" (206)	5 7/16" (138)	6 5/16" (160)	18 1/8" (460)	13 1/2" (343)	5 1/8" (130)	1 3/32" (28)	7 3/4" (197)
	89114-GD-HD												
	89114-GG-FGD												
	89114-GG-FGD-HD												
4"	89114-Q-FGD	4"	2 1/2"	2"	24 1/4" (616)	8 1/8" (206)	5 7/16" (138)	6 5/16" (160)	18 1/8" (460)	13 1/2" (343)	5 1/8" (130)	1 3/32" (28)	7 3/4" (197)
	89114-Q-FGD-HD												

sur demande : Filetage A : NPT - BSPP / Taraudage B : NPT - BSPP

8000HO simple circuit

A (BSP)	Référence	B (BSP)	F	E	G	C	W	Z	O
1/2"	8821-GD-P	1/2"	2 1/2" (64)	2 1/8" (54)	2" (51)	6 1/4" (159)	4 7/16" (112)	1 5/8" (42)	15/32" (12)
	8821-GG-FGD-P								
	8821-Q-FGD-P								
3/4"	8827-GD-P	3/4"	2 1/2" (64)	2 3/16" (55.5)	2 3/8" (60)	6 3/8" (162)	4 11/16" (119)	1 13/16" (46)	15/32" (12)
	8827-GG-FGD-P								
	8827-Q-FGD-P								
1"	8834-GD-P	1"	2 3/4" (70)	2 5/16" (59)	2 5/8" (67)	7 1/8" (181)	4 7/8" (123)	1 7/8" (48)	15/32" (12)
	8834-GG-FGD-P								
	8834-Q-FGD-P								
1 1/4"	8842-GD-P	1 1/4"	3 3/16" (81)	2 1/2" (64)	3 (76)	8 1/8" (206)	5 5/8" (142)	2 1/8" (53)	5/8" (15)
	8842-GG-FGD-P								
	8842-Q-FGD-P								
1 1/2"	8849-GD-P	1 1/2"	3 3/4" (95)	2 1/2" (64)	3 1/2" (89)	8 13/16" (224)	6" (152)	2 7/8" (73)	5/8" (15)
	8849-GG-FGD-P								
	8849-Q-FGD-P								
2"	8860-GD-P	2"	4" (102)	2 9/16" (65)	4" (102)	9 1/2" (241)	6 9/16" (167)	3 1/8" (79)	5/8" (15)
	8860-GG-FGD-P								
	8860-Q-FGD-P								
2 1/2"	8876-GD-P	2"	5 3/16" (132)	3 3/16" (81)	4 7/16" (113)	10 7/8" (276)	8" (203)	3 9/16" (90)	11/18" (17)
	8876-GG-FGD-P								
	8876-Q-FGD-P								
3"	8890-GD-P	2 1/2"	5 3/4" (146)	3 5/8" (92)	4 9/16" (116)	12 3/16" (309.5)	8 1/2" (216)	3 31/32" (101)	7/8" (22)
	8890-GG-FGD-P								
	8890-Q-FGD-P								

8000HO double circulation

A (BSP)	Référence	B (BSP)	C	F	E	G	S	W	Z	O	H	K	J (BSP)
1/2"	8921-GD-P	1/2"	7 1/2" (190.5)	2 1/2" (64)	2 1/8" (54)	2" (51)	6 1/16" (154)	4 7/16" (112)	1 5/8" (42)	15/32" (12)	2 1/4" (57)	1/8"	1/2"
	8921-GG-FGD-P												
	8921-Q-FGD-P												
3/4"	8927-GD-P	3/4"	7 11/16" (195)	2 1/2" (64)	2 3/16" (55.5)	2 3/8" (60)	6 1/4" (158.7)	4 11/16" (119)	1 13/16" (46)	15/32" (12)	2 5/16" (59)	1/4"	1/2"
	8927-GG-FGD-P												
	8927-Q-FGD-P												
1"	8934-GD-P	1"	8 3/4" (222)	2 3/4" (70)	2 5/16" (59)	2 5/8" (67)	6 15/16" (172)	4 7/8" (123)	1 7/8" (48)	15/32" (12)	2 5/8" (67)	3/8"	1/2"
	8934-GG-FGD-P												
	8934-Q-FGD-P												
1 1/4"	8942-GD-P	1 1/4"	9 1/4" (235)	3 3/16" (81)	2 1/2" (64)	3" (76)	7 7/8" (200)	5 5/8" (142)	2 1/8" (53)	5/8" (15)	3 1/8" (79)	1/2"	1/2"
	8942-GG-FGD-P												
	8942-Q-FGD-P												
1 1/2"	8949-GD-P	1 1/2"	10 3/8" (263.5)	3 3/4" (95)	2 1/2" (69)	3 1/2" (89)	8 5/8" (219)	6" (152)	2 7/8" (73)	5/8" (15)	3 9/16" (90)	3/4"	3/4"
	8949-GG-FGD-P												
	8949-Q-FGD-P												
2"	8960-GD-P	2"	11 11/16" (297)	4" (102)	2 9/16" (65)	4" (102)	9 1/2" (241)	6 9/16" (167)	3 1/8" (79)	5/8" (15)	4" (102)	3/4"	1"
	8960-GG-FGD-P												
	8960-Q-FGD-P												
2 1/2"	8976-GD-P	2"	14 1/8" (358.8)	5 3/16" (132)	3 3/16" (81)	4 7/16" (113)	11 1/4" (286)	8" (203)	3 9/16" (90)	11/16" (17)	1 1/4" 5 1/16" (128) 1"	**	1 1/4"
	8976-GG-FGD-P												
	8976-Q-FGD-P												
	8976-GD-P												
	8976-GG-FGD-P												
3"	8990-GD-P	2 1/2"	17" (431.8)	5 3/4" (146)	3 5/8" (92)	4 9/16" (116)	12 1/2" (318)	8 1/2" (216)	3 31/32" (101)	7/8" (12)	5 9/16" (141)	**	1 1/4"
	8990-GG-FGD-P												
	8990-Q-FGD-P												

sur demande : Filetage A : NPT - BSPP / Taraudage B et J : NPT - BSPP

** Nous consulter

Courbes pression/vitesse

pour vapeur saturée

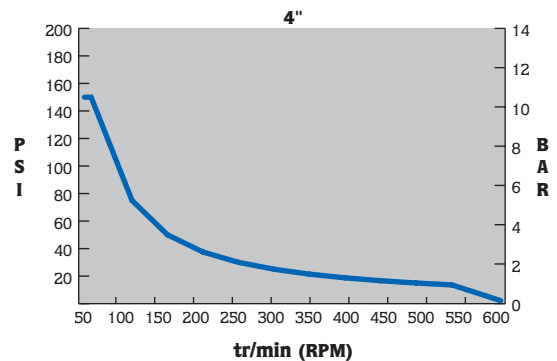
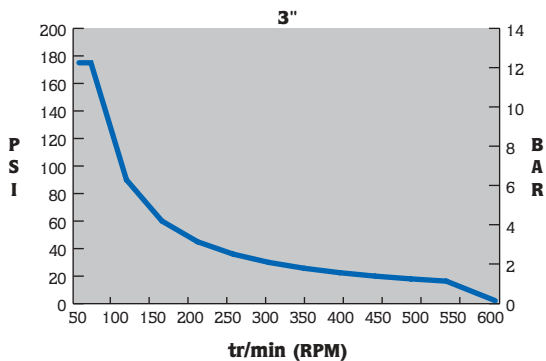
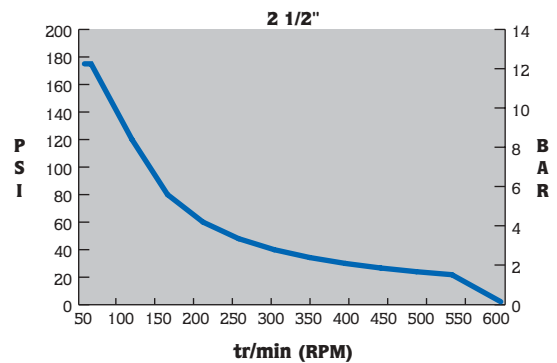
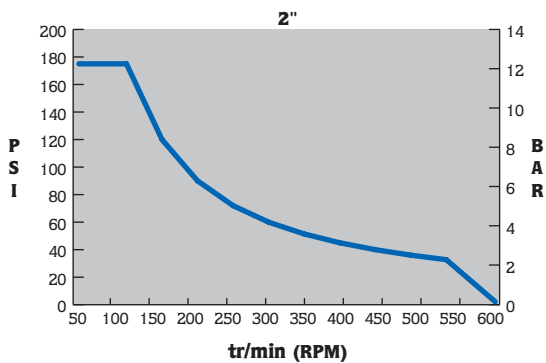
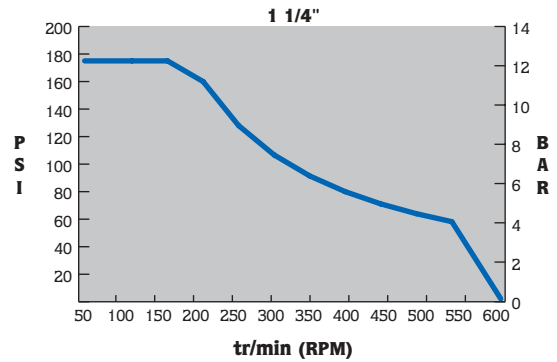
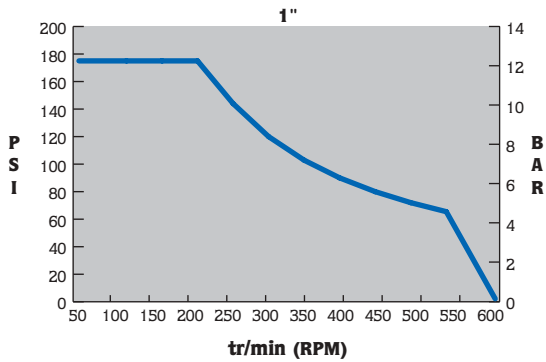
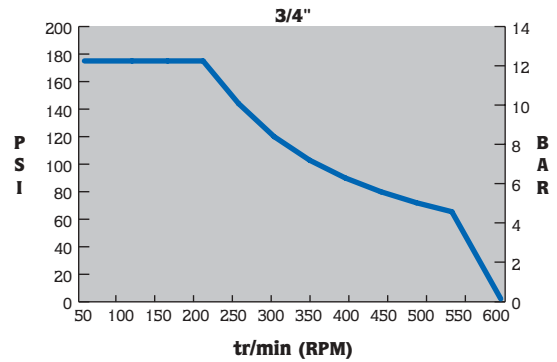
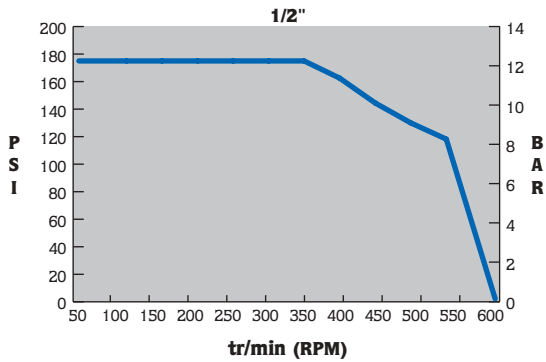

Courbes pression/vitesse (suite)

pour fluide caloporteur

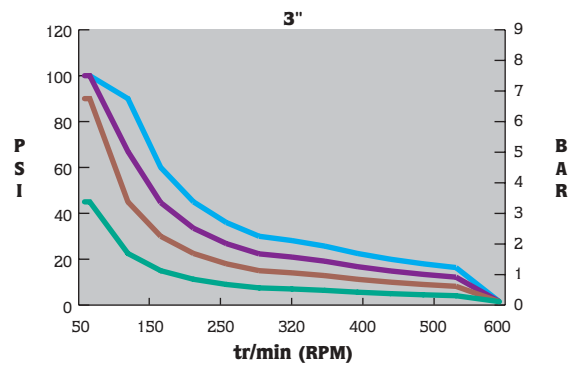
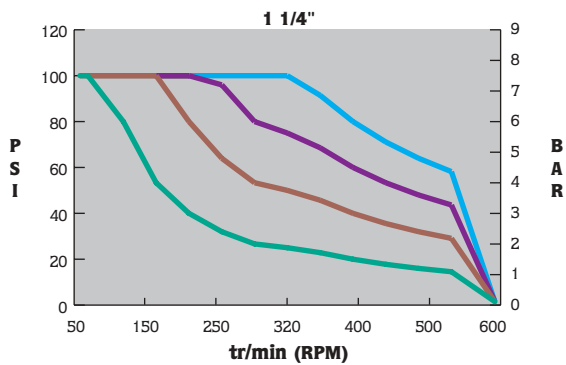
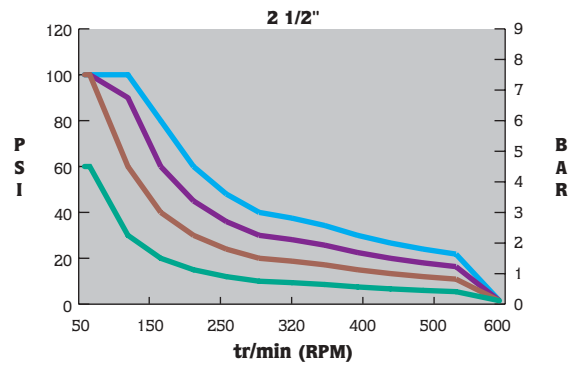
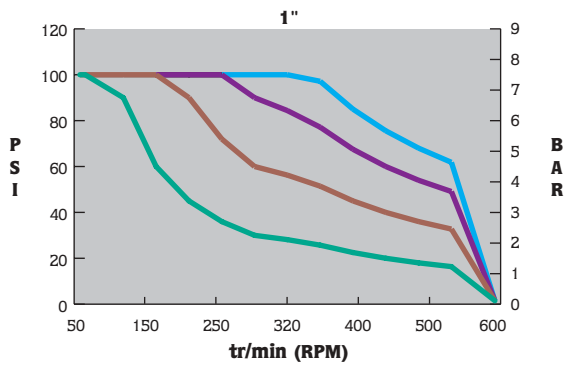
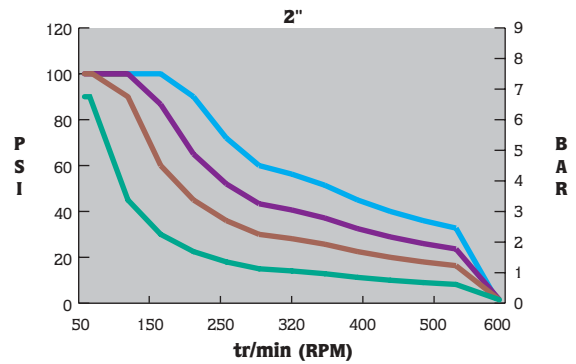
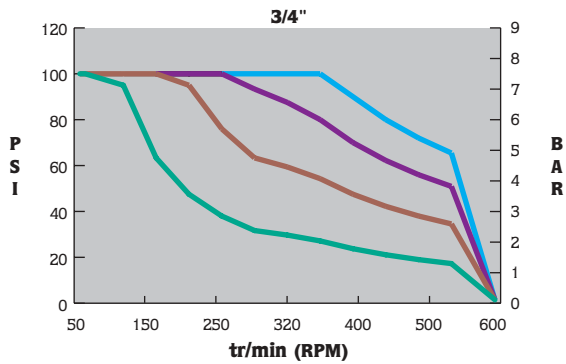
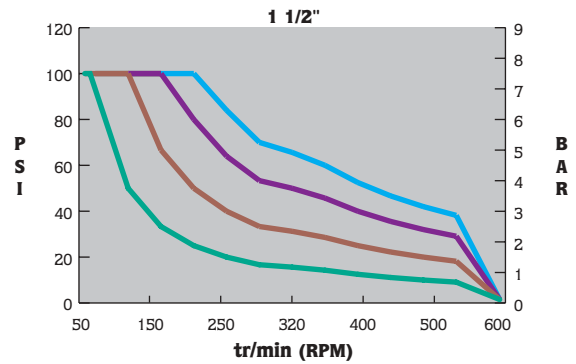
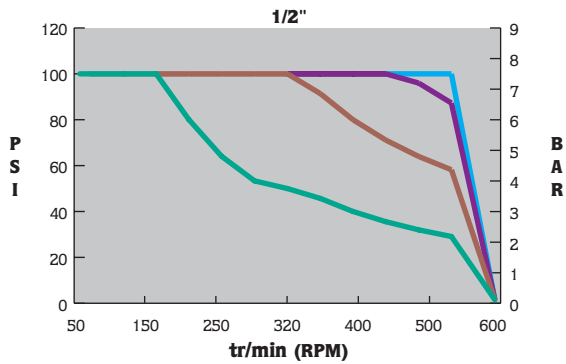

315°C 290°C 260°C 230°C